







Installation, Operation, & Maintenance
Model: 236CM, 248CM, Gas Infrared Cheesemelter



THE INFORMATION IN THIS MANUAL IS CRUCIAL AND MUST BE RETAINED FOR FUTURE REFERENCE. READ, UNDERSTAND AND FOLLOW THE INSTRUCTIONS AND WARNINGS CONTAINED IN THIS MANUAL.

<u>DANGER</u>	POTENTIALLY HAZARDOUS SITUATION WHICH, IF NOT AVOIDED, COULD RESULT IN DEATH.	
<u>WARNING</u>	POTENTIALLY HAZARDOUS SITUATION WHICH, IF NOT AVOIDED, COULD RESULT IN DEATH OR SERIOUS INJURY.	
<u>CAUTION</u>	POTENTIALLY HAZARDOUS SITUATION WHICH, IF NOT AVOIDED, MAY RESULT IN MINOR OR MODERATE INJURY.	
<u>NOTICE</u>	Helpful operation and installation instructions and tips are present.	

FOR YOUR SAFETY

DO NOT STORE OR USE GASOLINE OR OTHER FLAMMABLE VAPORS AND LIQUIDS IN THE VICINITY OF THIS OR ANY OTHER APPLIANCE.

WARNING: IMPROPER INSTALLATION, ADJUSTMENT, ALTERATION, SERVICE OR MAINTENANCE CAN CAUSE PROPERTY DAMAGE, INJURY OR DEATH. READ THE INSTALLATION, OPERATING AND MAINTENANCE INSTRUCTIONS THOROUGHLY BEFORE INSTALLING OR SERVICING THIS EQUIPMENT.

IF YOU SMELL GAS:













1. Shut off gas to the appliance
2. Extinguish any open flame.
3. If odor continues immediately call your dealer / installer or your fire department.

Model No:	Purchased From:
Serial No:	Location:
Date Purchased:	Date Installed:
Purchased Order No:	For Service Call:

**THE INFORMATION IN THIS MANUAL IS CRUCIAL AND MUST BE
RETAINED FOR FUTURE REFERENCE. READ, UNDERSTAND AND
FOLLOW THE INSTRUCTIONS AND WARNINGS CONTAINED IN THIS
MANUAL.**

TABLE OF CONTENTS

CHAPTER	PAGE
TABLE OF CONTENTS	3
READ FIRST	4
SAFETY PROCEDURES	6
EQUIPMENT DESCRIPTION	7
UNPACKING.....	8
INSTALLATION	9
INITIAL START UP	11
OPERATION	12
MAINTENANCE & CLEANING.....	14
TROUBLE SHOOTING	16
PARTS LIST	18
WIRING DIAGRAM	19

<u>CAUTION</u>	THE UNIT IS EXTREMELY HEAVY. FOR SAFE HANDLING, INSTALLER SHOULD OBTAIN HELP AS NEEDED, OR EMPLOY APPROPRIATE MATERIALS HANDLING EQUIPMENT (SUCH AS A FORKLIFT, DOLLY, OR PALLET JACK) TO REMOVE THE UNIT FROM THE SKID AND MOVE IT TO THE PLACE OF INSTALLATION.	
<u>CAUTION</u>	ANY STAND, COUNTER OR OTHER DEVICE ON WHICH THE UNIT WILL BE LOCATED MUST BE DESIGNED TO SUPPORT THE WEIGHT OF THE UNIT.	
<u>CAUTION</u>	SHIPPING STRAPS ARE UNDER TENSION AND CAN SNAP BACK WHEN CUT.	
<u>DANGER</u>	THIS APPLIANCE MUST BE GROUNDED AT THE TERMINAL PROVIDED. FAILURE TO GROUND THE APPLIANCE COULD RESULT IN ELECTROCUTION AND DEATH.	
<u>WARNING</u>	INSTALLATION OF THE UNIT MUST BE DONE BY PERSONNEL QUALIFIED TO WORK WITH ELECTRICITY AND PLUMBING. IMPROPER INSTALLATION CAN CAUSE INJURY TO PERSONNEL AND/OR DAMAGE TO EQUIPMENT. UNIT MUST BE INSTALLED IN ACCORDANCE WITH ALL APPLICABLE CODES.	
<u>NOTICE</u>	The data plate is located on the left side of unit behind the control door. The unit voltage, wattage, gas specifications, serial number, and clearance specifications are on the data plate. This information should be carefully read and understood before proceeding with the installation.	
<u>NOTICE</u>	The installation of any components such as a vent hood, grease extractors, fire extinguisher systems, must conform to their applicable National, State and locally recognized installation standards.	
<u>NOTICE</u>	Do not install the Cheesemelter over a Charbroiler or any other open flame appliance.	
<u>NOTICE</u>	During the first few hours of operation you may notice a small amount of smoke coming from the unit, and a faint odor from the smoke. This is normal for a new unit and will disappear after the first few hours of use.	
<u>CAUTION</u>	ALWAYS KEEP THE AREA NEAR THE APPLIANCE FREE FROM COMBUSTIBLE MATERIALS.	
<u>CAUTION</u>	KEEP FLOOR IN FRONT OF EQUIPMENT CLEAN AND DRY. IF SPILLS OCCUR, CLEAN IMMEDIATELY, TO AVOID THE DANGER OF SLIPS OR FALLS.	
<u>WARNING</u>	KEEP WATER AND SOLUTIONS OUT OF CONTROLS. NEVER SPRAY OR HOSE CONTROL CONSOLE, ELECTRICAL CONNECTIONS, ETC.	
<u>CAUTION</u>	MOST CLEANERS ARE HARMFUL TO THE SKIN, EYES, MUCOUS MEMBRANES AND CLOTHING. PRECAUTIONS SHOULD BE TAKEN TO WEAR RUBBER GLOVES, GOGGLES OR FACE SHIELD AND PROTECTIVE CLOTHING. CAREFULLY READ THE WARNING AND FOLLOW THE DIRECTIONS ON THE LABEL OF THE CLEANER TO BE USED.	

NOTICE

Service on this, or any other, LANG appliance must be performed by qualified personnel only. Consult your LANG authorized service agent directory or call the factory at 314-678-6315 or www.langworld.com For the LANG service agent nearest you.



WARNING

BOTH HIGH AND LOW VOLTAGES ARE PRESENT INSIDE THIS APPLIANCE WHEN THE UNIT IS PLUGGED/WIRED INTO A LIVE RECEPTACLE. BEFORE CLEANING, SERVICING OR REPLACING ANY PARTS, DISCONNECT THE UNIT FROM THE ELECTRIC POWER SUPPLY.



CAUTION

USE OF ANY REPLACEMENT PARTS OTHER THAN THOSE SUPPLIED BY LANG OR THEIR AUTHORIZED DISTRIBUTORS CAN CAUSE BODILY INJURY TO THE OPERATOR AND DAMAGE TO THE EQUIPMENT AND WILL VOID ALL WARRANTIES.



SAFETY PROCEDURES

Lockout Procedure

1. Announce lockout to other personnel.
2. Turn both heat and control power off at main panel.
3. Test lockout by turning power switch on and observing if fan(s) come on.
Check heater circuit with voltmeter.
4. Perform necessary repairs or tests.
5. Turn power on at main panel.
6. Announce unit is “on” to other personnel.

Safety Precautions

The Manufacturer, Lang Manufacturing, hereby disclaims any and all responsibility for injury, damage, loss or other claim that may occur to person or property from improper alteration, modification, addition, operation, maintenance or service, whether it be mechanical, electrical, fuel, operator motor or otherwise, which may occur from such improper alteration, modification, addition, operation, maintenance or service to this piece of equipment.

Safety Considerations

Your Lang Melter is manufactured to rigid standards. This equipment is N.S.F and ETL listed and meets safety and sanitation standards.

The presence of safety equipment control and interlocks on an appliance and attendant components of installation cannot in and of themselves, assure absolute safety of operation. Diligent, capable, well trained operators and maintenance personnel, as well as proper programs of operation and maintenance, are essential to the safe and reliable operation of this appliance.

- A. The **responsibility of the manufacturer** is to supply suitable, comprehensive instructions and recommendations for the operation and maintenance of the appliance.
- B. Trained qualified and factory-authorized personnel must perform all operation, maintenance and repair of these appliances. It is the **responsibility of the owner / operator** to ensure that this happens.
- C. A regular periodic program of cleaning, inspection and maintenance must be established and comprehensive maintenance records maintained. It is the **sole responsibility of the user** to establish, schedule and enforce the frequency and scope of these programs in keeping with recommended practice and with due consideration given to actual operating conditions.
- D. The appliance must be operated within the limits, which will not exceed the working limits of any component within the appliance as a whole.

EQUIPMENT DESCRIPTION

Lang Model: 236CM, 248CM Gas Infrared Cheesemelter

Exterior

The unit dimensions are 28" (71cm) High without legs, 21" (53cm) Deep, and 36", 48" (91cm, 122cm,) Wide dependent on the actual model number.

The Sides, Bottom, and Rear wall are of constructed stainless steel.

The melter cavity is insulated with high temperature insulation for efficiency and reduced heat loss.

Interior

The interior dimensions are 10" (25.4cm) High, 14½" (36.8cm) deep, and 33", 45" (83.8cm, 114.3cm) Wide.

The melter comes standard with one rack, which can be placed in four different positions.

The melter has a rack sensitive micro-switch for a quick and easy activation.

Controls

Power Switch	Applies power to the unit for operation
Mode Switch	Sets the mode between Constant heat and Automatic heat
Manual Gas Valve	Turns main gas valve on
Micro-Switch	Activates main burner when in Automatic Mode

UNPACKING

<u>CAUTION</u>	THE UNIT IS EXTREMELY HEAVY. FOR SAFE HANDLING, INSTALLER SHOULD OBTAIN HELP AS NEEDED, OR EMPLOY APPROPRIATE MATERIALS HANDLING EQUIPMENT (SUCH AS A FORKLIFT, DOLLY, OR PALLET JACK) TO REMOVE THE UNIT FROM THE SKID AND MOVE IT TO THE PLACE OF INSTALLATION.
<u>CAUTION</u>	ANY STAND, COUNTER OR OTHER DEVICE ON WHICH THE UNIT WILL BE LOCATED MUST BE DESIGNED TO SUPPORT THE WEIGHT OF THE UNIT.
<u>CAUTION</u>	SHIPPING STRAPS ARE UNDER TENSION AND CAN SNAP BACK WHEN CUT.



Receiving the Unit

Upon receipt, check for freight damage, both visible and concealed. Visible damage should be noted on the freight bill at the time of delivery and signed by the carrier's agent. Concealed loss or damage means loss or damage, which does not become apparent until the merchandise has been unpacked. If concealed loss or damage is discovered upon unpacking, make a written request for inspection by the carrier's agent within 15 days of delivery. All packing material should be kept for inspection. Do not return damaged merchandise to Star Manufacturing International. File your claim with the carrier.

Location

Prior to un-crating, move the unit as near its intended location as practical. The crating will help protect the unit from the physical damage normally associated with moving it through hallways and doorways.

Un-crating

The unit will arrive completely assembled inside a wood frame covered by cardboard box and strapped to a skid. **Remove the cardboard cover, cut the straps and remove the wood frame.**

INSTALLATION

DANGER

THIS APPLIANCE MUST BE GROUNDED AT THE TERMINAL PROVIDED. FAILURE TO GROUND THE APPLIANCE COULD RESULT IN ELECTROCUTION AND DEATH.



WARNING

INSTALLATION OF THE UNIT MUST BE DONE BY PERSONNEL QUALIFIED TO WORK WITH ELECTRICITY AND PLUMBING. IMPROPER INSTALLATION CAN CAUSE INJURY TO PERSONNEL AND/OR DAMAGE TO EQUIPMENT. UNIT MUST BE INSTALLED IN ACCORDANCE WITH ALL APPLICABLE CODES.



NOTICE

The data plate is located on the left side of unit behind the control door. The unit voltage, wattage, gas specifications, serial number, and clearance specifications are on the data plate. This information should be carefully read and understood before proceeding with the installation.



NOTICE

The installation of any components such as a vent hood, grease extractors, fire extinguisher systems, must conform to their applicable National, State and locally recognized installation standards.



COUNTER TOP INSTALLATION

Legs must be installed on this appliance if it is to be configured as a counter top model.

Attach the legs to the body by screwing the threaded stud of the leg into the nut insert provided under each bottom corner of the machine. Tighten each leg with a wrench.

Adjust the legs so that burners are level. Leg adjustment is made by turning the adjustable foot at the bottom of each leg. Ensure that the leg does not turn while adjusting the foot.

WALL HUNG INSTALLATIONS

The illustration, below, shows the connection points for the gas and electrical and how the wall bracket is to connect to the Cheesemelter.

The heat shield is shipped in the 4-inch space at the rear of the machine.

Instructions for installing the heat shield are provided with the shield. Follow the instructions carefully. It is important to remember to remove the knockouts from the front edge of the machine after the heat shield is installed.

Minimum clearance from the cooking surface below to the bottom of this appliance is 17 inches.

A wall hanging bracket is provided. It is shipped in the 4-inch space at the rear of the machine. Attach the bracket to the wall studs then hang the machine on the bracket.

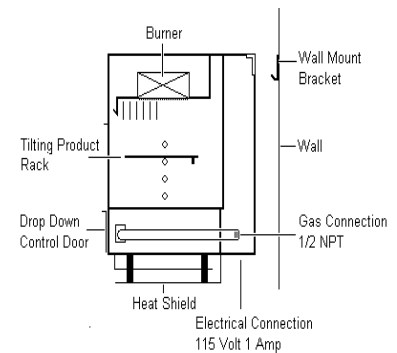

ELECTRICAL CONNECTION

The electrical connection must be made in accordance with local codes or in the absence of local codes with NFPA No. 70 latest edition (in Canada use: CAS STD. C22.1).

Each appliance requires a 115 volt grounded supply at 1 amp.

Supply wire size must be large enough to carry the amperage load for the number of appliances being installed. Wire size information can be found on the data plate.

The electrical diagram for the unit is behind the lower front access panel.

INSTALLATION CONT'D

GAS CONNECTION

This appliance must be installed under a ventilation hood. The installation of any components such as vent hoods, grease extractors, fire and smoke detection devices, or fire extinguisher systems, must conform to N.F.P.A Standard #96, latest edition.

This appliance is manufactured for use with the type of gas indicated on the data plate. Contact the factory if the gas type does not match that which is on the data plate.

All gas connections must be in accordance with local codes and comply with the National Fuel Gas Code ANSI Z223.1 latest edition.

Gas must be delivered to the appliance regulator at less than 1/2 pound of pressure and less than 1/2 inch water column pressure drop.

The regulator on this appliance is set to 6 inches water column for natural gas and 10 inches water column for propane. A 1/8 inch NPT tap is provided on the main manifold for checking regulator pressure.

When replacing the 1/8 inch plug in the main manifold a joint sealant that is resistant to the action of liquid petroleum gas must be used.

The supply piping must be of sufficient size to provide 10,000 BTU/hr per foot of Cheesemelter. A 1/2 inch NPT connection is provided at the lower right rear corner.

A gas shut off valve must be installed to the appliance and located in an accessible area. In the event of a significant drop in gas pressure, turn the shut off valve off and contact your gas supplier.

This appliance and its individual shutoff valve must be disconnected from the gas supply piping system during any pressure testing of that system at test pressures in excess of 1/2 PSIG (3.45 kPA) and the appliance must be isolated from the gas supply piping system by closing its individual manual shutoff valve during any pressure testing of the gas supply system at test pressures equal to or less than 1/2 PSIG (3.45 kPA).

Test for gas leaks. Use a commercial leak detector or a soap and water solution.

NOTICE

Do not install the Cheesemelter over a Charbroiler or any other open flame appliance.



VENTILATION AND CLEARANCES

Standard minimum clearance from combustible construction is as follows:

To prevent the function of this appliance from being affected by a reduced atmospheric pressure, adequate make-up air in the kitchen should be provided to replace the air taken out by the ventilating system.

- 6" from side
- 0" from back
- 4" from floor or 12" from high heat source

When mounting over a range top griddle or any other high heat source a bottom clearance of 12" must be maintained and the heat shield (provided with all wall mount units) must be installed. Failure to maintain this clearance and / or to install the heat shield will the equipment warranty

INITIAL START UP

NOTICE

During the first few hours of operation you may notice a small amount of smoke coming from the unit, and a faint odor from the smoke. This is normal for a new unit and will disappear after the first few hours of use.



PRE-POWER ON

After the melter is connected to power and gas, prior to turning on, verify the following:

- The manual gas valve opens and closed freely.
- The rack moves up and down freely
- All packing material has been removed from the melter.
- The melter has no gas leaks.

POWER ON & PILOT LIGHTING

Lighting Instructions:

The pilot burner must be lit with a match. Gas flows to the pilot as soon as all the gas valves are turned On. Be aware that it may take a few minutes, on new installations, for gas to be present at the pilot burner, as air must first be purged from the gas line.

The pilot burner will remain lit even if the Cheese Melter is switched to Off.

Once the pilot burner is lit, allow one minute for pilot to heat enough to enable the main burner to light.

Set the Constant - Auto switch to Constant and allow the machine to run for five minutes. A small amount of smoke may emanate from the machine as it heats, do not be alarmed as this is a normal condition related to the burning off of oils associated with the manufacturing process. Set the Constant - Auto switch to Auto to place the machine into the Stand-by mode.

Note: Electrical power is required to safely operate this cheesemelter. This unit will not operate in the event of a power failure, but pilot gas will continue.

TO SHUTDOWN UNIT

Turn off electrical supply to the unit and shut off the gas supply manual valve located in the gas supply line at the bottom of the unit at the rear gas entry.

OPERATION

- CAUTION** ALWAYS KEEP THE AREA NEAR THE APPLIANCE FREE FROM COMBUSTIBLE MATERIALS.
- CAUTION** KEEP FLOOR IN FRONT OF EQUIPMENT CLEAN AND DRY. IF SPILLS OCCUR, CLEAN IMMEDIATELY, TO AVOID THE DANGER OF SLIPS OR FALLS.



GENERAL

The Lang gas melter can be used to poach, sauté and brown. In addition to melting cheese on sandwiches, French onion soup, hot apple pie and casseroles, it may be used for finishing Italian, Mexican and au gratin dishes utilizing less energy than conventional broilers.

The product is heated with 1650°F of infrared heat, which penetrates the product preventing burning and scorching. The rack is counterbalanced so that maximum heat is supplied only when the product is placed in the rack.

Although the heating elements are not directly controlled to regulate heat, the exposure of the product to heat is adjustable. Heat adjustment may be obtained by raising and lowering the rack position. The shelf positions provide a choice of cooking positions for a variety of applications. The top position is very hot, and can be used for quick browning and toasting, with the heat decreasing at each lower position.

In order to change positions, simply slide the rack in and out of the slots provided. Make sure that the end of the rack engages the sliding mechanism located on the right front corner.

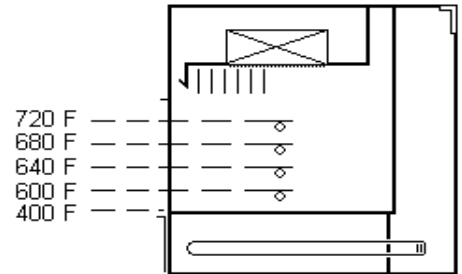

CONTROLS

There are very few controls that operate the gas cheese melter. Below is a list of the various components with a description of their purpose.

- Power Switch** Turns the unit On and Off.
- Constant / Auto Switch** When set to Constant, the burner(s) will light and stay on. When set to AUTO, the burner(s) will light whenever a product is placed onto the Tilting Product Rack.
- Manual Gas Valve** This valve turns off the flow of gas to the burner(s). Once the machine is installed, this valve need not be turned off as the POWER SWITCH should be utilized to shut the machine down. The manual gas valve **cannot** be used to regulate the heat output from the burner(s), it must be full ON or full OFF.
- Tilting Product Rack** The Tilting Product Rack is used to adjust the amount of heat a product is exposed to and to start the burner(s) when the machine is placed into the Auto mode. Raising the tilting product rack increases the heat on the product while lower the rack decreases the heat.

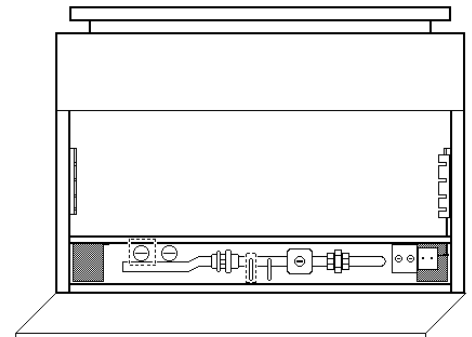

- Manual On - Off Valve
 - Electric Solenoid
 - Pilot Burner Adjuster
 - Regulator
 - Pipe Union
 - Power and Constant Auto Switches
 - Product Rack Switch
- These components on 4 and 5 Foot Models Only

OPERATING DO'S AND DON'TS

DO:

- Insure all dishes placed in the melter are oven safe.
- Pre-heat pans in the melter or on a stove.
- Turn products halfway through cooking, as needed.
- Use the unit in Automatic as much as possible, use Constant during peak periods.

DON'TS

- Do not use the melter as a cooking or baking device; it is best suited for finishing dishes immediately prior to serving.
- Do not use the unit to heat or thaw chilled or frozen product.
- Do not place aluminum foil on the rack or bottom shelf. This will reflect heat and expose components to unnecessary high temperatures.
- Do not move rack from one position to another without hand protection.

MAINTENANCE & CLEANING

WARNING

KEEP WATER AND SOLUTIONS OUT OF CONTROLS. NEVER SPRAY OR HOSE CONTROL CONSOLE, ELECTRICAL CONNECTIONS, ETC.



CAUTION

MOST CLEANERS ARE HARMFUL TO THE SKIN, EYES, MUCOUS MEMBRANES AND CLOTHING. PRECAUTIONS SHOULD BE TAKEN TO WEAR RUBBER GLOVES, GOGGLES OR FACE SHIELD AND PROTECTIVE CLOTHING. CAREFULLY READ THE WARNING AND FOLLOW THE DIRECTIONS ON THE LABEL OF THE CLEANER TO BE USED.



CLEANING

The unit should be thoroughly cleaned once a day to insure against accumulation of foreign material.

- Always start with the unit cold & disconnect from its electrical source.
- The stainless exterior can easily be cleaned using stainless steel cleaner
- Always follow the cleaner manufacturer's instructions when using any cleaner.
- Care should be taken to prevent caustic cleaning compounds from coming in contact with the blower wheel.
- The oven racks, rack slides, and interior may be cleaned using oven cleaner.
- Discoloration or heat tint may be removed using a Carbon Release oven cleaner.
- The oven interior should be cleaned using a mild soap and a non-metal scouring pad. **DO NOT use caustic cleaners.**

Always apply these cleaners when the oven is cold and rub in the direction of the metal's grain.

MAIN BURNER ACCESS

The main burner is removed through the top of the machine.

Remove the stainless steel top-front first by removing six sheet metal screws from the ends.

Remove the entire top assembly by removing several sheet metal screws along the edge of the top.

Remove the gas line from the burner at the compression fitting on the orifice.

Remove the two nuts at the opposite end of the burner from the orifice.

Lift the main burner from the machine.

MAIN BURNER ORIFICE ACCESS

The main burner orifice can be access without taking the burner from the machine.

Remove the stainless steel top-front first by removing six sheet metal screws from the ends.

Remove the entire top assembly by removing several sheet metal screws along the edge of the top.

Remove the gas line from the burner at the compression fitting at the orifice.

Unscrew the orifice fitting from the burner.

MAINTENANCE & CLEANING Cont'd

PILOT BURNER ADJUSTMENT

Pilot flame adjustment is accomplished at the brass tube fitting on the main manifold.

The brass fitting located between the regulator and the solenoid valve which has the 1/8 inch tube connected to it is the adjuster.

Turn the hex head screw clockwise to shorten the pilot flame, and counterclockwise to lengthen the pilot flame.

- The pilot must light the main burner within 5 seconds of gas being available at the burner tiles (listen for the solenoid valve to open).
- The pilot must light the main burner without snuffing itself out.
- The pilot must continue to burn during an extended continuous operation of the main burner.

RACK SWITCH ADJUSTMENT

The rack switch is located at the extreme right of the control compartment.

The Tilting Product Rack should energize the tilt switch at the mid-point in its travel.

To adjust the switch, bend the actuator arm.

TROUBLESHOOTING

Symptoms

What follows is a chart of Symptoms, Possible Causes, and Remedy's to aid in diagnosing faults with the unit.
 Refer to the Symptoms column to locate the type of failure then to the Possible Cause for the items to be checked. On the following pages is a chart with the possible causes and the test to properly identify the problem.

Always start with the unit cold & disconnect from its electrical source before cleaning or servicing.

SYMPTOM	POSSIBLE CAUSE
Unit will not come on	<ul style="list-style-type: none"> • Defective outlet • Tripped Circuit Breaker • Defective Power Switch
Pilot will not light	<ul style="list-style-type: none"> • Plugged orifice • Incorrect water column • Defective regulator • Defective pilot valve
Burner will not light	<ul style="list-style-type: none"> • Auto / Constant switch in incorrect position. • Defective regulator • Plugged main orifice • Incorrect water column • Defective solenoid valve • Low pilot • No gas to unit • Defective tile assembly

NOTICE Service on this, or any other, LANG appliance must be performed by qualified personnel only. Consult your authorized service station directory or call the factory at 314-678-6315, or www.langworld.com For the service agent nearest you.



WARNING BOTH HIGH AND LOW VOLTAGES ARE PRESENT INSIDE THIS APPLIANCE WHEN THE UNIT IS PLUGGED/WIRED INTO A LIVE RECEPTACLE. BEFORE REPLACING ANY PARTS, DISCONNECT THE UNIT FROM THE ELECTRIC POWER SUPPLY.



CAUTION USE OF ANY REPLACEMENT PARTS OTHER THAN THOSE SUPPLIED BY LANG OR THEIR AUTHORIZED DISTRIBUTORS CAN CAUSE BODILY INJURY TO THE OPERATOR AND DAMAGE TO THE EQUIPMENT AND WILL VOID ALL WARRANTIES.



TROUBLESHOOTING Cont'd

TEST

Possible Cause	Test
Tripped Circuit Breaker	<ul style="list-style-type: none">• Reset Circuit breaker and re-test
Defective Power Switch, Constant / Auto switch	<ul style="list-style-type: none">• Check switch for normal operation
Defective Power Cord	<ul style="list-style-type: none">• Check Power cord for continuity*
Defective Regulator	<ul style="list-style-type: none">• Check unit for proper Water Column*
Plugged Orifice	<ul style="list-style-type: none">• Clean orifice*
Faulty Solenoid Valve	<ul style="list-style-type: none">• Check Coil for 120V*
Low Pilot	<ul style="list-style-type: none">• Confirm that pilot is steady and about 1" on both sides.

* A factory authorized service representative should perform this work.

PARTS LIST

July 22, 2008, Rev. C

GAS CHEESE MELETER: 236CM & 248CM

DESCRIPTION	PART NO.
Switch Toggle On-Off	2E-30303-06
Pilot Light 208/240V 6" Lead Black Body	2J-31601-01
Rack, 2ft	2B-50200-13
Rack, 3ft	2B-50200-14
Rack, 4ft	2B-50200-15
Rack, 5ft	2B-50200-29
Spring Regulator LP	2P-51001-10
Spring Regulator NG	OB-51001-11
Micro Switch Assembly	J9-51100-12
Pilot Burner Assembly Mod. Kit	J9-60101-18
Valve Manual Main Burner, 4ft & 5ft Units	2V-70402-05
Valve Manual Gas Pilot Burner	2V-70402-06
Valve Manual Main Burner, 3ft Units	2V-70402-07
Magnetic Catch w/Strike	2C-9788
Knob Gas On-Off Chrome	2R-70701-43
Infrared Gas Burner 15 5/16" Long, 2ft, 4ft & 5ft Units	2F-80005-01
Infrared Gas Burner 26 7/8" Long, 3ft & 5ft Units	2F-80005-02
Manifold Gas Melter, 3ft, 4ft & 5ft Units	2K-80100-10
Manifold Gas Melter, 4ft & 5ft Units	2K-80100-11
Pilot Burner Assembly	2J-80201-20
Orifice Pilot Burner .010 DRL LP	2A-80401-09
Orifice Pilot Burner .021 DRL NG	2A-80401-11
Orifice Gas Spud #42 DRL NG 30k for 26 7/8" Burner	2A-80404-03
Orifice Gas Spud #48 DRL NG 20k for 15 5/6" Burner	2A-80404-09
Orifice Gas Spud #52 DRL LP 30k for 26 7/8" Burner	2A-80404-13
Orifice Gas Spud #55 DRL LP 20k for 15 5/6" Burner	2A-80404-16
Orifice Gas Spud #45 DRL NG for 15 5/16" Burner (Chili's Only)	2A-80404-23
Orifice Gas Spud #38 DRL NG for 26 7/8" Burner (Chili's Only)	2A-80404-24
Orifice Gas Spud #54 DRL LP for 15 5/16" Burner (Chili's Only)	2A-80404-27
Orifice Gas Spud #50 DRL LP for 26 7/8" Burner (Chili's Only)	2A-80404-28
Regulator Gas Set 6" NG	2V-80501-01
Regulator Gas Set 10" LP	2V-80501-03
Valve Solenoid Gas 120 VAC	2V-80502-01
Flame Switch 24" Gas Grid, 236CM	NLA
Drip Pan Assy 3'	J9-GM-175
Drip Pan Assy 4'	J9-GM-176

REVISION BLOCK						
REV	ECN NO.	DESCRIPTION	DR:	MFG	ENG	DATE
B	6872	REMOVED FLAME SWITCH	LRC			5/02/08

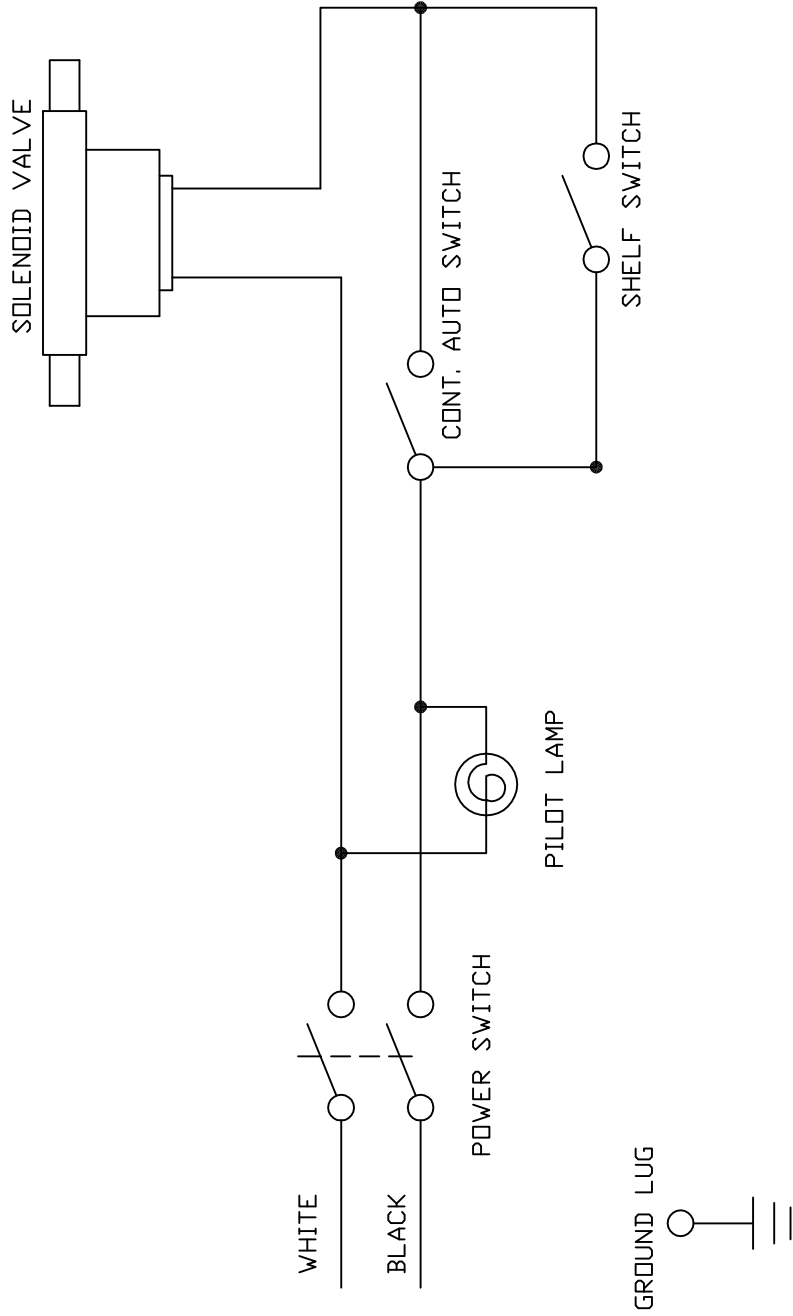

QTY	ITEM	PART NUMBER	DESCRIPTION / MATERIAL
LANG MANUFACTURING			
DR: SRC DATE: 22-96		TITLE: LBL WIRING DIAGRAM , GAS	
CHK'D DATE: 22-96		CHEESE MELTER 120VAC	
TOLERANCES		NEXT HIGHER ASSY. SHEET	
FRACTIONS		DRAWING NUMBER	
DECIMALS		REV	
# 1/64		1 OF 1	
X # .05		2M-61115-05	
ANGLES		B	
# 5			
.XXX ± .015			
UNLESS OTHERWISE SPECIFIED			
DIMENSIONS ARE IN INCHES			
SCALE: N/A			

STAR INTERNATIONAL HOLDINGS INC. COMPANY

Star - Holman - Lang - Wells - Bloomfield - Toastmaster

10 Sunnen Drive, St. Louis, MO 63143 U.S.A.

(314) 678-6303

www.star-mfg.com